



ECLIPSE *Ni/Ci* Upright Microscope



Shedding New Light On **MICROSCOPY**

See the evolution

The ECLIPSE Ni series upright biological microscope supports bioscience studies with enhanced basic performance and flexible system expandability.

The CFI Plan Apochromat Lambda D series objectives are the key to the series' optical performance. Their uniform brightness and superb image quality up to the edge of the large field of view of FOV25 allow seamless image stitching and highly accurate quantitative analysis.

Nikon's proprietary stratum structure allows the epi-fluorescence attachment to be installed in two layers, allowing simultaneous mounting of two different apparatus, such as a fluorescence observation device and a laser photoactivation device, on a single microscope.

The Ni series transcends the concept of conventional upright microscopes and expands the possibilities of advanced research in fields such as bioscience and medicine.

The ECLIPSE Ci series is a compact research microscope which has highly functional and user-friendly features. Nikon provides a wide variety of research microscopes, including for shared use at research facilities and for personal use at laboratories.

Ni

■ System expandability

- Nikon's proprietary stratum structure enables efficient system construction.
- The numerous accessories can be custom combined depending upon application.

■ Optical performance

- CFI Plan Apochromat Lambda D series objectives with high image quality over the entire field of view and corrected chromatic aberration from 405 nm.
- Silicone immersion objectives that enable acquisition of high signal-to-noise ratio images even deep within the sample.

■ Design

- 3D ergo design combines functionality with sophistication.

■ Operability

- Ni-E: Motorized model with automatic change of observation conditions and adjustment of microscope accessories.
- Ni-U/Ni-L: Manual model with some motorized options.
- Most microscope controls can be operated with easy-to-reach buttons on the front of the Ni-E.



Versatile microscopes meet all demands

Manual and motorized models

To meet diverse user demands for operability, system expandability and motorized control, Nikon provides three Ni series models. The Ni-U and Ni-L, which have compatibility with some motorized accessories, are manual models suitable for high-quality image observation and digital imaging. The Ni-E is a fully motorized model that is efficient for experiments requiring comprehensive control of various devices, such as photoactivation devices and confocal systems.

Ni-U/Ni-L (manual models)

- Ergonomic tube and stage handle height adjustment mechanism allow comfortable viewing positions.
- Stratum structure and sturdy design improve expandability.
- Motorized nosepiece and motorized epi-fluorescence cube turret can be utilized.
- The Ni-U supports halogen light sources. The Ni-L incorporates an LED light source that achieves color reproducibility equivalent to that of a halogen light source while delivering a greater amount of light than a halogen light source.



Ni-L configured with an ergonomic binocular tube

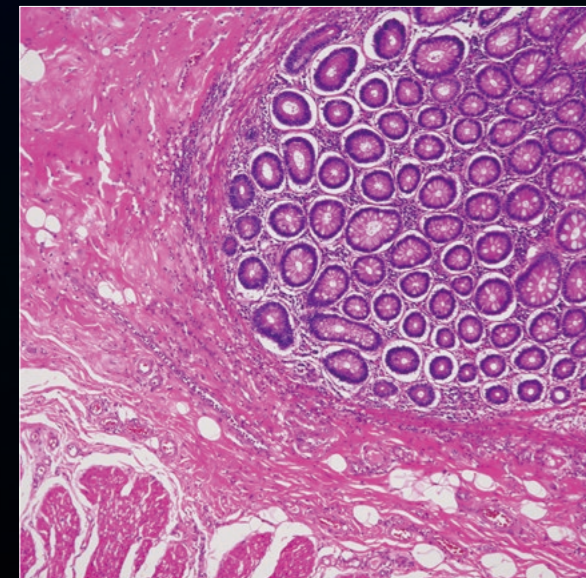

High color rendering LED light source (Ni-L)

The high color rendering LED light source built-into the Ni-L provides natural color reproducibility comparable to a halogen light source, as well as light uniformity, long life, and other advantages associated with LEDs, making it effective for observation of pathological specimens.

HE-stained image of human pathological tissue captured with Ni-L, configured with a CFI Plan Apochromat Lambda D 10X objective and a Digital Sight 10 camera
Image courtesy of: Dr. Yasushi Nakamura, pathologist, Osaka Cytopathological Laboratory

Compact lamphouse-free design (Ni-L)

The Ni-L has a built-in LED light source for diasopic illumination, resulting in a space-saving design whose depth is approximately 150 mm shorter than that of the Ni-U, contributing to effective workspace utilization.



Ni-E (motorized model)

- High-precision motorized focusing
- Broad range of motorized accessories that can be used in combination.
- Observation conditions can be changed at a simple push of a button.
- Stratum structure and sturdy design improve expandability.
- 3D ergo design buttons with improved operability are located close together for speedy operations.
- Microscope settings in use can be verified on the display.
- Two focusing mechanism options: focusing stage and focusing nosepiece



Ni-E configured with a motorized epi-fluorescence cube turret and motorized universal condenser

Ni-E provides fully motorized operations

Automatic adjustment with objective changeover

Condenser, aperture and field diaphragm, and ND filter are automatically set to the optimal position during objective changeover. In addition, stage XYZ travel amount per handle rotation and parfocal distance deviation correction are automatically adjusted. Microscope settings can also be manually adjusted.

Change of observation conditions

Selected observation conditions can be designated to individual buttons, enabling changes to be made at the push of a button. This is particularly convenient when reproducing specific observation conditions.



High-precision motorized focusing

High-precision Z-focus incorporated by the Ni-E provides accurate Z-position information required for use with confocal imaging systems. Individual coarse and fine focus knobs provide enhanced ease of operation.



Expandable system broadens application possibilities

Confocal imaging (Ni-E)

Combining the Ni-E's high-precision Z-focus mechanism with an AX series confocal microscope system allows high-resolution, high-S/N-ratio imaging of 3D structures of organs and cells. The Ni-E has a highly stable structure suitable for mounting a confocal scanner and features a wide luminous flux that enables bright confocal imaging.

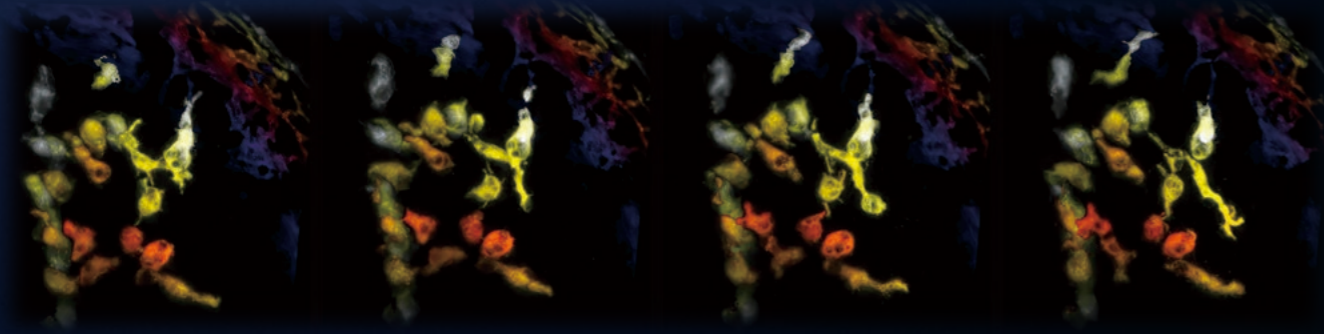

3 dimensional reconstruction Z series (color coded by Z depth) of microglial movement in developing zebrafish, obtained with high speed resonant imaging and piezo Z stepping. Courtesy of Dr. E. Burton, Department of Neurology, University of Pittsburgh.

AX/AX R confocal microscope

The AX incorporates a high-definition (up to 8192 x 8192 pixels) galvano scanner. In addition to the galvano scanner, the AX R also incorporates a high-speed (up to 720 fps) and high-resolution (up to 2048 x 2048 pixels) resonant scanner, enabling true simultaneous photoactivation and confocal imaging. AX/AX R allows acquisition of a large area of the sample with a large diagonal field of view of 25mm, reducing phototoxicity.

Focusing mechanism that can be selected according to the sample and application

The focusing mechanism of the Ni-E can be selected from the focusing stage type and the focusing nosepiece type. The focusing nosepiece type enables fixed-stage configuration to meet the requirements of experiments such as *in vivo* imaging.



Configuration with Ni-E focusing stage type

Configuration with Ni-E focusing nosepiece type

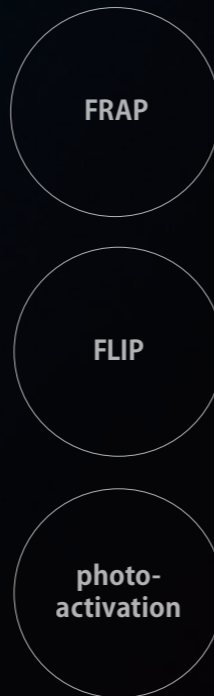

Simultaneous multichannel imaging (Ni-E/Ni-U/Ni-L)

The Ni's back port and the quadrocular tilting tube allow the user to acquire simultaneous, two-channel images on separate cameras. This feature is invaluable for applications such as FRET.



Simultaneous imaging with two cameras

The Ni's flexible stratum structure allows the back camera port unit and the epi-fluorescence attachment to be mounted at the same time, enabling simultaneous image acquisition of two different wavelengths with each camera. This enables the capture of high-resolution images in the entire frame for each wavelength without dividing the CCD chip. The use of individual cameras for acquisition allows the user to tailor acquisition parameters for each channel independently, allowing acquisition of high-sensitivity FRET images.

* For information about compatible cameras, contact Nikon or Nikon dealers.



Enhanced system expandability provides the right solution for your needs

Ni series accessories are segmented by function, allowing you to select required units and flexibly combine them to create lean and effective system configurations.

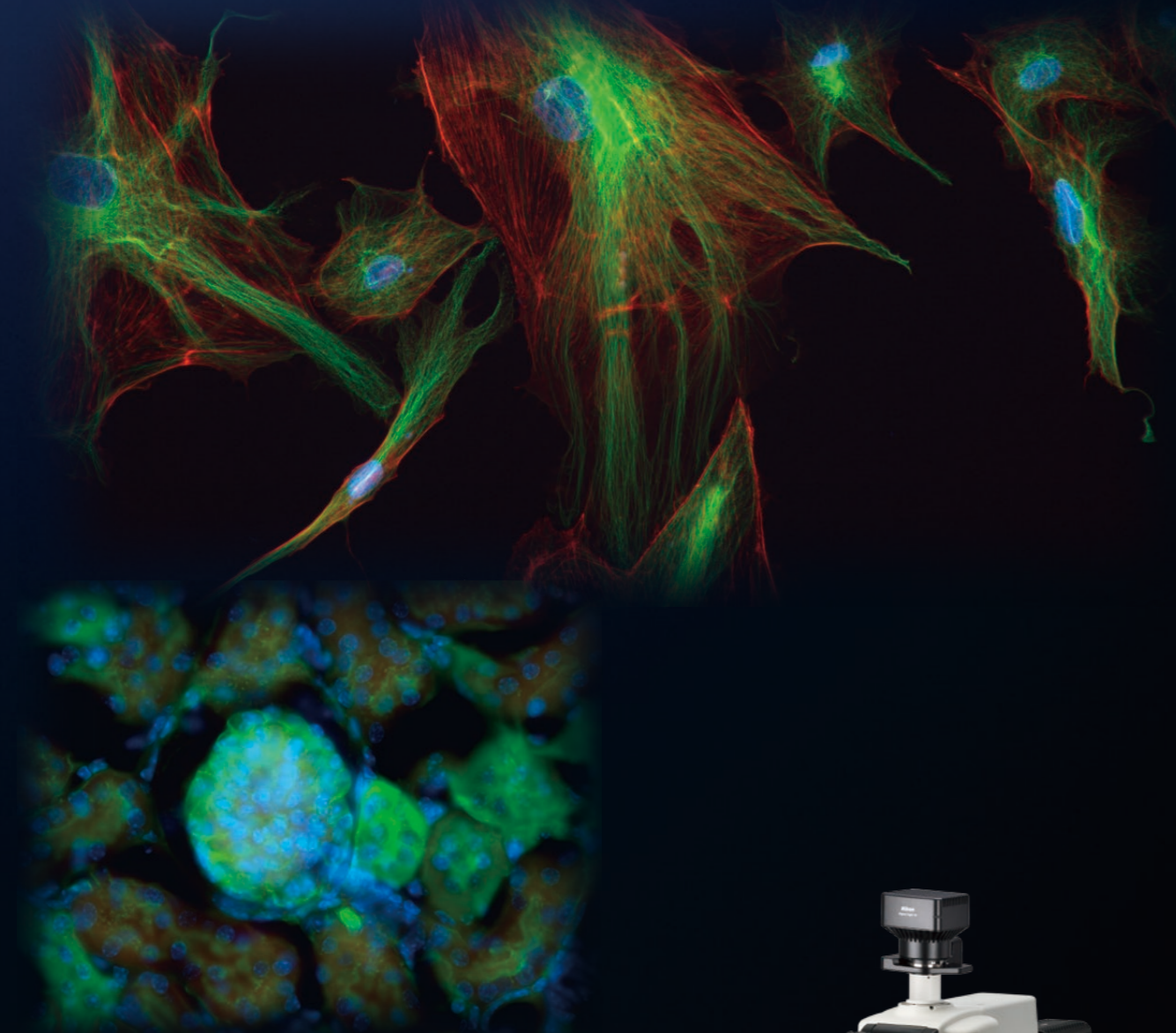

System configuration for acquiring multi-stained specimen images

The motorized epi-fluorescence cube turret shutter, which helps to reduce photobleaching of specimens, is easily operated with a convenient remote control pad.

Images are automatically acquired by controlling the motorized accessories, including the epi-fluorescence cube turret according to the camera settings such as exposure time, camera gain, and time interval.

This configuration is recommended for those who conduct mostly fluorescent observations rather than brightfield observations.



Configuration of manual microscope Ni-U with motorized epi-fluorescence cube turret, epi-fluorescence attachment, motorized septuple nosepiece, digital camera Digital Sight 10, simple remote control pad, control box B

System configuration for acquiring pathological specimen images

Optimal brightness can be automatically adjusted with objective changeover, eliminating the need for manual adjustment. By controlling the optical zooming of the motorized DSC zooming port for quadocular tube, it is possible to capture images with the desired angle of field while maintaining the image quality.



Configuration of motorized microscope Ni-E with motorized quadocular tilting tube, motorized DSC zooming port, motorized ND filter, digital camera DS-F13, motorized XY stage and joystick, control box A

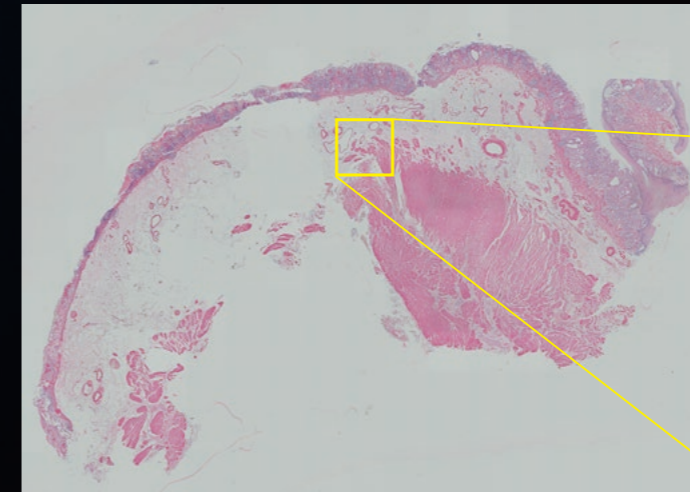

SMA antibody-stained gastric wall (17 x 12 stitched image). Images courtesy of Nichirei Biosciences Inc.

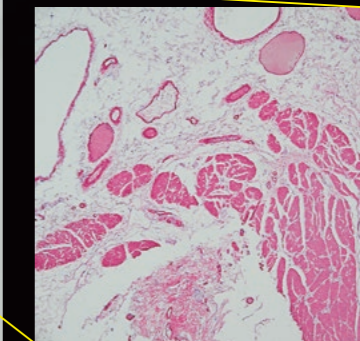

60X (8 x 8 stitched image)

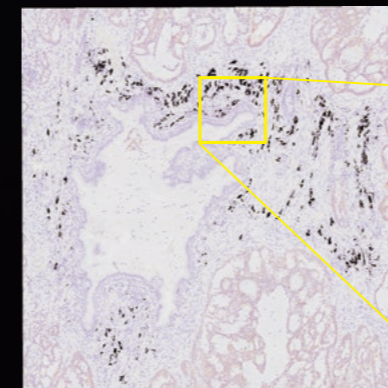

ALK antibody-stained lung cancer. Images courtesy of Nichirei Biosciences Inc.

60X

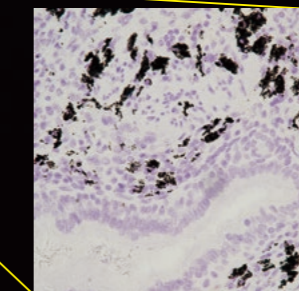

4X

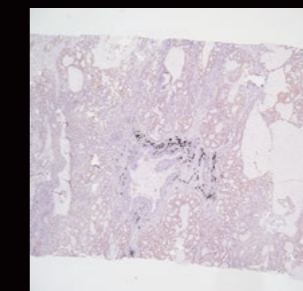

40X (8 x 8 stitched image)

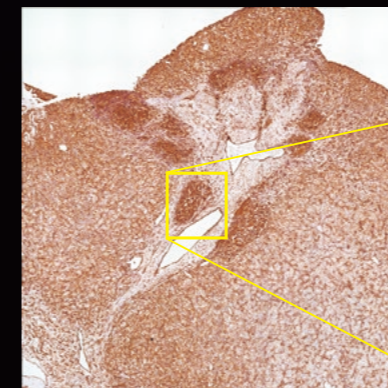

Vimentin antibody-stained kidney cancer. Images courtesy of Nichirei Biosciences Inc.

40X

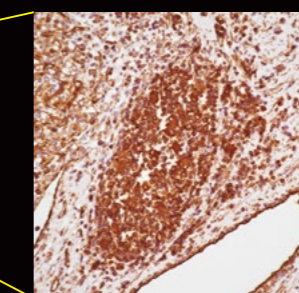

20X

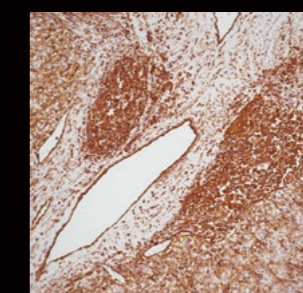

Technologies supporting the Ni series

High optical performance

As a light microscope manufacturer, Nikon has cultivated high technical capabilities and confidence. With its advanced technologies extending from optical glass production to lens design, fabrication, coating and processing, Nikon provides unsurpassed optical performance.

High-performance objective lens

● CFI Plan Apochromat Lambda D series

The high-refractive index glass used in the oil-immersion objectives provides uniform brightness and high image quality up to the periphery of a large 25 mm diagonal field of view, enabling efficient acquisition of seamless stitched images and supports macro imaging of large samples. High transmittance and chromatic aberration correction over a wide wavelength range from 405 nm to 850 nm enable reliable quantitative data acquisition for intensity analysis of nuclear staining. These high NA lenses are ideal for brightfield and DIC observations, as well as fluorescence and confocal observations.



Nano Crystal Coat

This anti-reflective coating that consists of nanometer-size particles is based on semiconductor manufacturing technology and is also used for Nikon camera lenses. The coarse structure with particles arranged in a spongy construction with uniform spaces between them enables extremely low refractive indices.

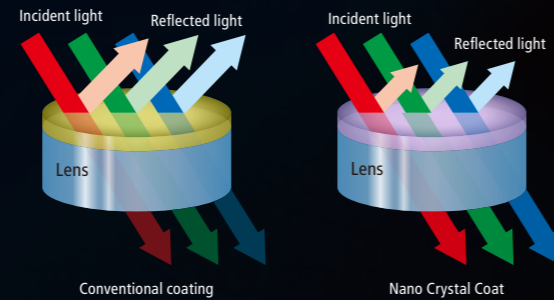

● Water dipping objective lenses

CFI Apochromat NIR 40X W/60X W objectives, with long working distances and high NA and transmission, provide clear observation over the near-IR wavelength range. Axial chromatic aberration is corrected up to the near-IR range, enabling high-resolution images of minute structures of thick samples during IR-DIC observations.

CFI75 Apochromat 25XC W and CFI Plan Achromat100XC W objectives featuring high NA (1.10) and long working distance (2.00 mm at 25XCW, 2.50 mm at 100XCW) are corrected for chromatic aberration in the IR range. These objectives can capture crisp images of deep regions of thick samples by adopting a mechanism to compensate for changes in spherical aberration that occur at different temperatures and observation point depths.



Uniformly bright illumination

The "fly-eye" lens is ideally suited to diascopic illumination optical systems. Uniform and bright illumination up to the viewfield periphery is provided at any magnification.

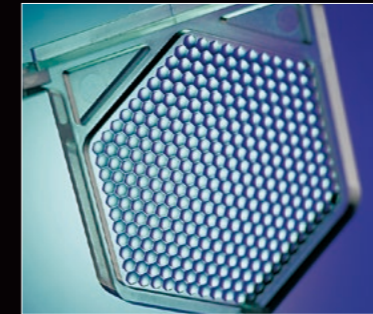

Fluorescence noise elimination

Nikon's proprietary noise terminator mechanism is employed in the epi-fluorescence cube turret and filter cubes. The S/N ratio has been dramatically improved by thoroughly eliminating stray light in the filter cubes, allowing images of weak fluorescent signals to be captured with high contrast and brightness.

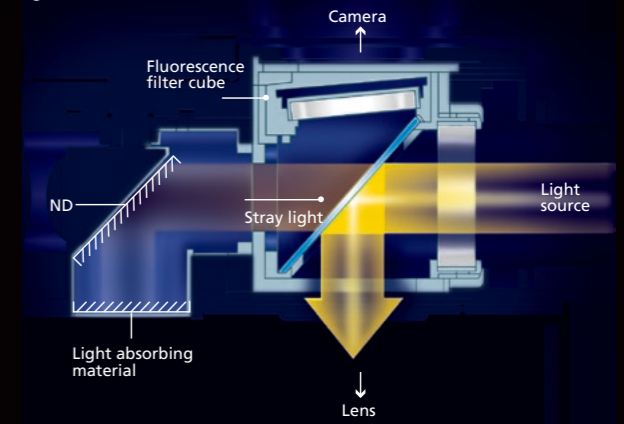

Clear image acquisition with all observation methods

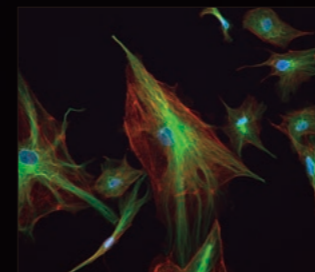

Epi-fluorescence observation

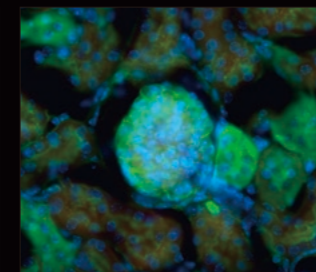

DIC (Differential Interference Contrast) observation

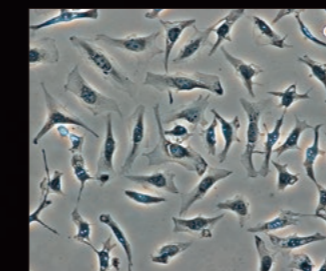
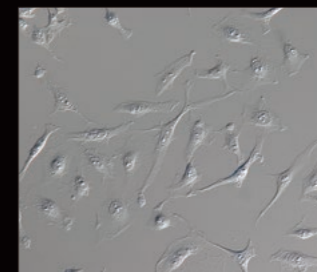

Phase contrast observation

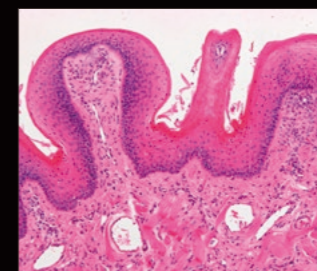
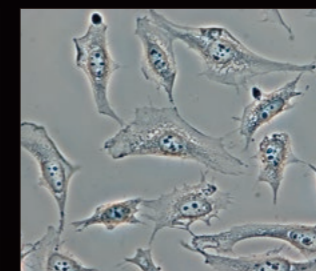

Brightfield observation

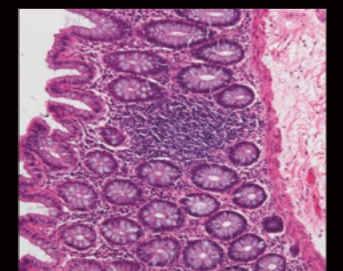

Ultimate ease, speed and clarity in imaging

The Ni series can be controlled in conjunction with a Digital Sight series digital camera, facilitating effortless digital imaging. Images can be captured with a dedicated button on the microscope body. Camera control from the software GUI on a PC and the touchscreen on a tablet PC is also possible.

Image capture button

Images can be acquired by simply pressing the image capture button located on the microscope base.



Digital Sight series cameras for microscopes

The optimal camera for your specific imaging needs can be selected from the Digital Sight series of cameras, which offers various features such as high sensitivity, high resolution, high speed image acquisition, and high color reproducibility.

F-mount cameras

● Microscope Camera Digital Sight 10

This 23.90-megapixel, high-definition camera is equipped with a Nikon FX-format CMOS sensor. The high frame rate of up to 66 fps (1920 x 1080 pixels) enables fast focusing. The color/monochrome capture modes can be easily switched by attaching and detaching the filter. Color fluorescent images can be clearly captured with its low-noise design.



● Monochrome Microscope Camera Digital Sight 50M

Digital Sight 50M is a 60-megapixel high-definition camera equipped with a high-sensitivity monochrome CMOS sensor. The ROI mode enables high-speed image capture of up to 225.9 fps (640 x 480 pixels). Its high sensitivity, with a quantum efficiency of 85%, makes it the ideal camera for quantitative analysis of fluorescence intensity changes.



C-mount camera

● Microscope Camera DS-Fi3

Equipped with a 5.9 megapixel CMOS image sensor. It provides high-definition imaging up to 2880 x 2048 pixels and up to 30 fps of fast imaging. With superior color reproduction and high sensitivity, images that are faithful to samples can be acquired during various observation methods, such as brightfield, DIC, phase contrast and epi-fluorescence.



NIS-Elements imaging software

Various packages are available to suit the user's imaging applications, including NIS-Elements L, which allows easy image acquisition, and NIS-Elements Ar, Br, and D, which enable advanced image acquisition through integrated control between a camera and microscope.



● NIS-Elements L

NIS-Elements L imaging software, featuring simple and user-friendly GUI, allows easy camera setting and image capturing using Digital Sight 10 and DS-Fi3 microscope cameras.

Enables image/movie acquisition and storage using a tablet PC*, facilitating effective sharing of images and presentations. Also supports touch screen operation.

*For information about compatible tablet PCs, contact Nikon.



Scene modes

The scene modes function enables the optimal camera setting for each sample and imaging technique by simply choosing the type of illumination or stain.

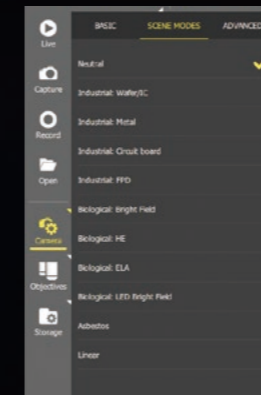

Split-screen display

The split-screen display function enables real-time comparisons between live and captured images by displaying them side-by-side and synchronizing zooming between both images.

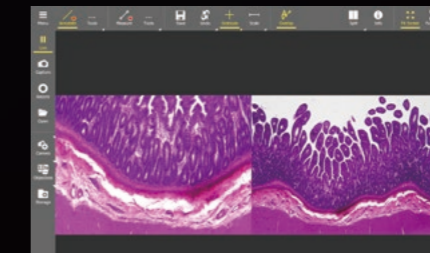

Measurement

Simple measurement functions, such as distance measurement between two points, area measurement and angle measurement, are available.

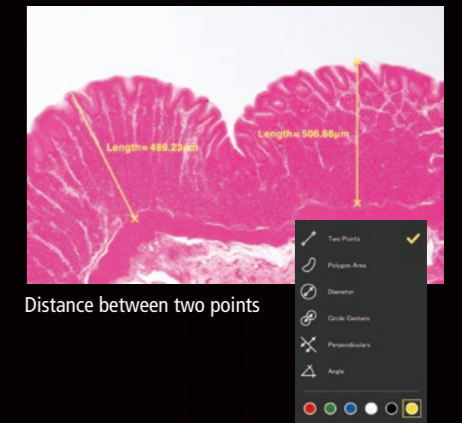

● NIS-Elements Ar, Br, D

The NIS-Elements Ar, Br and D packages seamlessly integrate cameras, peripheral devices, and the motorized functions and accessories of Ni, serving as a powerful yet easy-to-use interface for complex imaging experiments.

NIS-Elements D allows time-lapse, Z-series and multi-point acquisition, while Ar allows multi-dimensional image acquisition of up to 6D (x, y, z, t, multichannel and multipoint) and Br allows up to 4D.

Powerful tools for quick processing, measurement and acquired data management provide a one-step solution for acquisition and analysis.

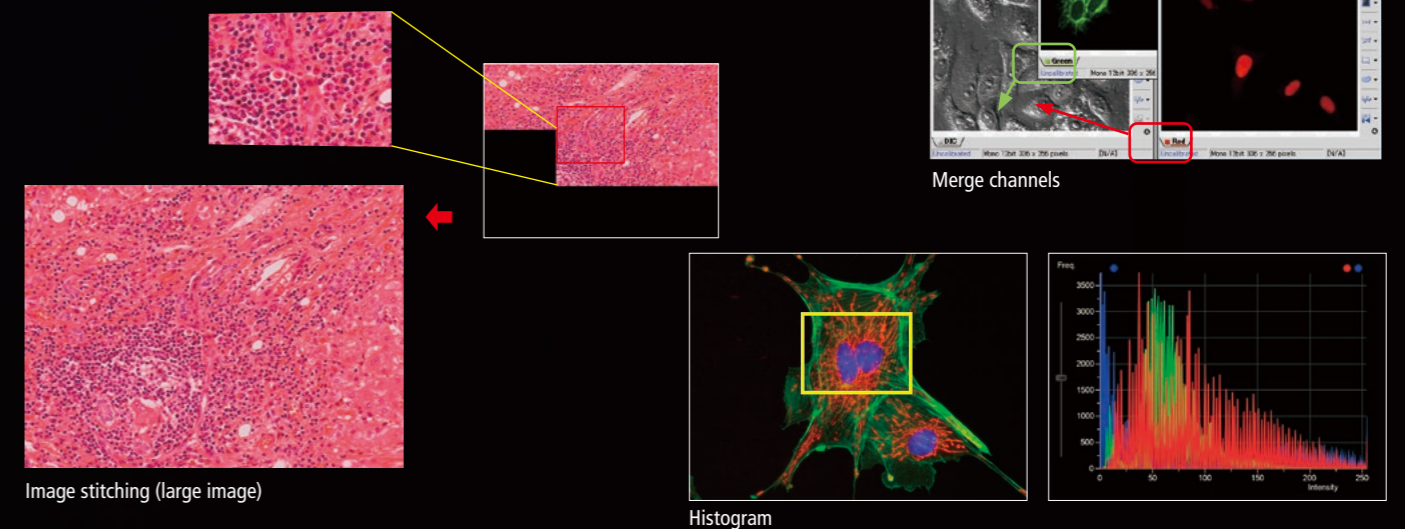

Image stitching (large image)

Histogram

Feel the evolution

Nikon has drawn on its proven optics and mechanical design technologies to develop the compact and high-performance ECLIPSE Ci series research microscope.

Ci-E and Ci-L plus adopt Nikon's unique, high-intensity LED as the light source for diascopic observation. High-quality objectives and high S/N epi-fluorescence attachments provide bright and high contrast fluorescence images. Image capture of specimens is easy and efficient when the microscope is configured with Nikon Digital Sight series cameras. With its high-optical performance and advanced easy control, the ECLIPSE Ci series supports research using a broad range of illumination techniques including phase contrast, darkfield and simple polarizing.

Ci

- High-intensity, uniform LED illumination (Eco-illumination)
- Epi-fluorescence attachments equipped with noise terminator mechanism
- Reliable high-performance objectives
- Observation and image capture with comfortable posture
- Motorized magnification switching by the push of a button (Ci-E)
- Automatic adjustment of light intensity and scale display linked to magnification switching
- Simple image capturing by the push of a button on the microscope
- Enables a wide variety of observations



Configuration of Ci-L plus with epi-fluorescence attachment and Digital Sight 10 camera

High quality images powered by Nikon's reputed optical technologies

Nikon's well-reputed optical technologies enable the capture of sharp and high quality images in a wide variety of techniques, including brightfield and epi-fluorescence observations.

The epi-fluorescence attachments of the ECLIPSE Ci series allow weakly fluorescent specimens to be captured with great clarity and brightness.

Epi-fluorescence attachments

The ECLIPSE Ci series has the option of a dedicated compact epi-fluorescence attachment capable of accepting 4 filter cubes. The noise terminator mechanism allows bright, high-contrast, high signal to noise (S/N) ratio fluorescence image capturing.

The name and position of the mounted filter cubes are displayed with phosphorescent labels for easy identification in darkened rooms. The filters or dichroic mirrors in the filter cubes can be easily replaced to create a more specific combination.

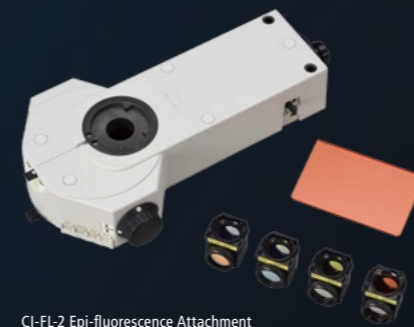

CI-FL-2 Epi-fluorescence Attachment

High-optical performance objectives

● CFI Plan Apochromat Lambda D series

These lenses provide uniform brightness and high image quality up to the edge of the large 25 mm field of view, and their high transmittance and chromatic aberration correction over a wide wavelength range from 405 nm to 850 nm make them ideal for multicolor fluorescence observation. The new design, which expands the effective diameter of the lens, improves NA and provides bright and clear images.



● CFI Plan Fluor series

Featuring an extra-high transmission rate, especially in the ultraviolet wavelength, combined with flatness of field, this series is perfect for fluorescence observation and imaging. These objectives can function as multi-purpose objectives for brightfield, fluorescence and simple/sensitive color polarizing observations.

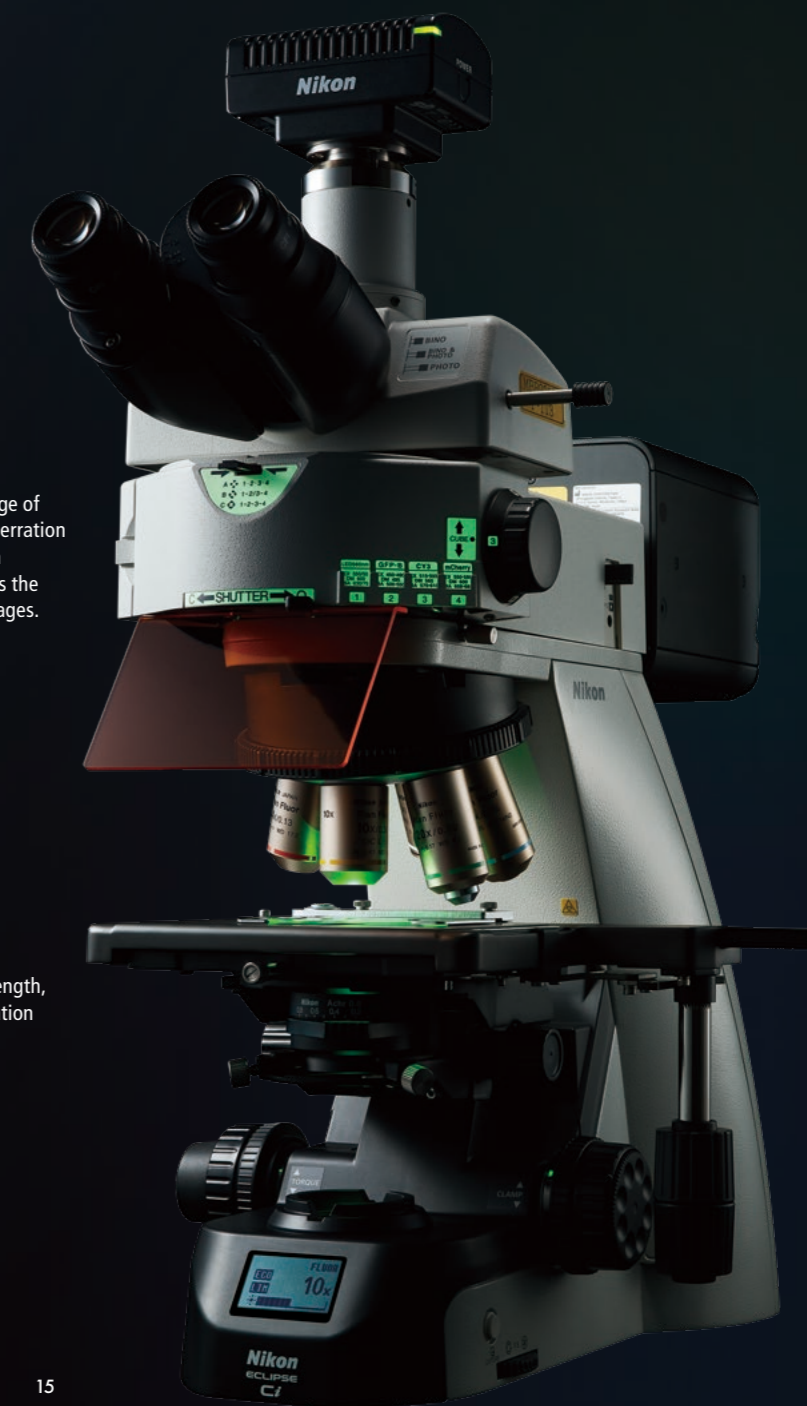

Unparalleled basic performance

Eco-illumination

By combining a collimator lens, fly-eye optics and LED illumination, bright and uniform images up to the periphery can be obtained. The LED is a low power consumption unit that reduces lamp replacement frequency thanks to its long-life, and provides the same color temperature in every magnification.

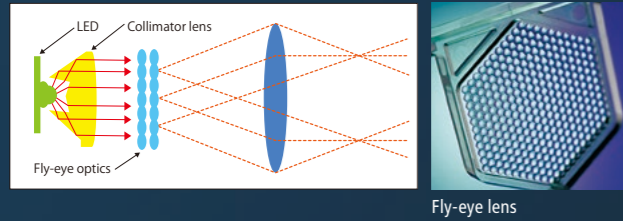

Auto light intensity reproduction

The user-defined light intensity for each objective is recorded by pressing a knob for Ci-L plus, and automatically recorded for Ci-E. The light intensity level is automatically recalled and applied when the objective is used again, eliminating the need for manual readjustment.



Push the knob on the Ci-L plus briefly to record the intensity.

Automatic scale bar adjustment linked to magnification change

The Ci-E/Ci-L plus nosepiece detects the state of the objective in use and automatically adjusts the scale bar in the image based on the magnification, eliminating the need for manual adjustment.

*Requires dedicated camera and software (optional).



Image capture button

Imaging with the Digital Sight series cameras is possible with the one touch button located on the microscope base.



Motorized magnification switching model Ci-E

Nosepiece rotating buttons

The nosepiece can be rotated with one-touch button control. Your two favorite magnifications can be registered*, and one press of the button alternates between these two objectives.

* Using the remote control pad.



Remote control pad

By programming specific buttons to correspond to specific objectives, magnification can be easily changed with a one touch button.



Automatic adjustment linked to objective switching

When the objective is switched, not only is the user-defined light intensity reproduced, but also the top lens element of the condenser automatically swings in or out according to the selected objective.

Versatile diasopic observation techniques

● Phase contrast

Eco-illumination has sufficient light intensity for phase contrast microscopy that is used in a wide range of applications including dermatological examinations.



● Darkfield

Enables clear observation of blood or the minute structure of flagella. Dry- and oil-type condensers are available. The expander lens is used to obtain illumination with greater brightness.



Left: C-DD Dark Field Condenser Dry
Right: C-DO Dark Field Condenser Oil

● Simple polarizing

This is ideal for observing bi-refringent samples such as collagen, amyloids and crystals.

*Two types of analyzer are available: intermediate tube type and nosepiece slider type.



Adjustable design to suit the user's natural posture

The angle and extension of the ergonomic binocular tube can be adjusted while mounting a camera. The height of the stage and its handle can be adjusted, enabling observation in a comfortable posture.



The tubes can also be lifted in 25 mm increments using the eyelevel riser.



The stage handle height can be changed to ensure a comfortable hand position.



The stage handle height can be changed to ensure a comfortable hand position.

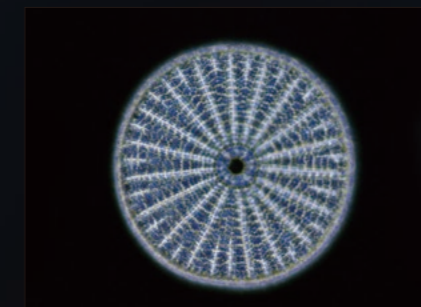
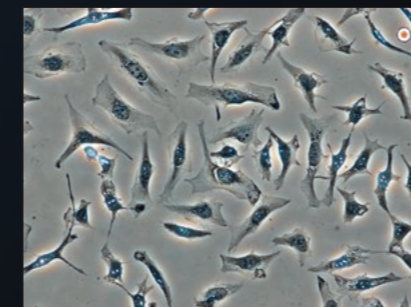

Optional accessories

Accessories for extending the functionality of Ni



Motorized quadrocular tilting tube (Ni-E)
Motorized changeover of optical paths is possible. Eyepiece inclination can be adjusted from 15° to 35°.



Motorized DSC zooming port (Ni-E)
A digital camera can be mounted on the camera port. A motorized 0.6X - 2.0X zoom optical system is incorporated.



Motorized epi-fluorescence cube turret (Ni-E, Ni-U, Ni-L)
Noise terminator provides high S/N ratio. Six filter cubes can be installed.



Back port unit (Ni-E, Ni-U, Ni-L)
Enables simultaneous acquisition of images with two different wavelengths using two cameras.



D-LEDI Fluorescence LED Illumination system (Ni-E, Ni-U, Ni-L)
An LED light source for fluorescence observation that can be directly attached to an epi-fluorescence attachment in the same way as a lamp house.

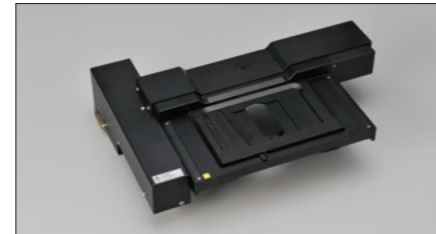

Motorized XY stage (Ni-E)
Effective for applications that require highly accurate positioning, such as photoactivation imaging and FISH.



Joystick for motorized stage (Ni-E)
Makes control of motorized XY stage possible.



Ergo controller (Ni-E)
In addition to motorized microscope operation, XYZ control of stage is possible with similar operational ease as that of an actual microscope.



Motorized DIC sextuple nosepiece (Ni-E, Ni-U, Ni-L)
Objective magnification is automatically saved along with the captured image. Built-in prism/analyzer plate slot.



Motorized universal condenser Dry (Ni-E)
High-speed motorized changeover of condenser modules for brightfield, phase contrast, DIC and simple darkfield observations is possible.



Motorized ND filter (Ni-E)
Brightness is automatically optimized with the changeover of the motorized nosepiece. Motorized adjustment of desired brightness is also possible.



Motorized shutter (Ni-E, Ni-U, Ni-L)
Capable of high-speed shutter control, enabling minimum photobleaching of samples.



High color rendering LED lamphouse (Ni-E)
A compact LED light source that provides high intensity and superior color reproducibility. It supports diascopic illumination for brightfield, darkfield, phase contrast, DIC and simple polarizing observations.



Simple remote control pad (Ni-U, Ni-L)
Motorized operation of the nosepiece, epi-fluorescence cube turret and shutter is possible.



Shutter cassette for Ni-L (Ni-L)
By blocking light from the LED light source and autofluorescence, this unit allows acquisition of high S/N fluorescence images without the need to turn off the diascopic illumination.

Teaching heads for Ni-U/Ni-L/Ci

Share specimen images while observing under a microscope

The teaching head allows simultaneous observation of the same field of view observed under a microscope, with the same brightness. The "side-by-side" type and "face-to-face" type are available, and both can be combined.



Teaching unit side by side

Teaching unit face to face

Built-in pointer to indicate the area of interest

- **Long-life LED**
Uses low heat generation and power saving LEDs. It has a longer life than halogen lamps and does not require lamp replacement.

- **Two-color switchable**
The pointer color can be switched between orange and green.

Flexible support for simultaneous observation by multiple users

By combining the "side-by-side" type and the "face-to-face" type, it is possible to configure for simultaneous observation by 3, 5, and 10 people.
* The configuration for 5 and 10 people is for Ni only.



For 3 persons

For 5 persons

For 10 persons

Epi-fluorescence light sources for Ni/Ci

D-LEDI Fluorescence LED illumination system

An eco-friendly light source optimized for fluorescence observation. It is a light source that can be directly mounted on the epi-fluorescence attachment in the same way as a lamp house, and provides sufficient light intensity for fluorescence observation.



D-LEDI Fluorescence LED illumination system

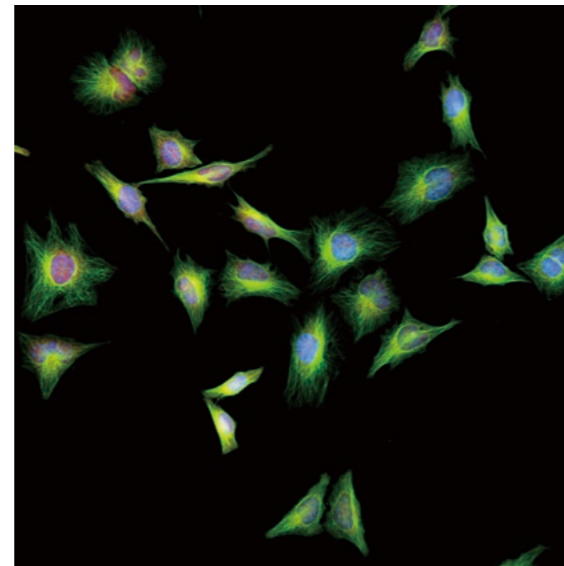

HeLa cells captured with CFI Plan Apochromat Lambda 40XC objective



configured with Ni-L

Wavelength intensity control

Four types of LEDs (with main wavelengths of 385 nm, 475 nm, 550 nm and 621 nm) are equipped to support excitation wavelengths commonly used for fluorescence observation. Using the included controller, the user can simultaneously turn on/off individual, multiple or all wavelength lights. Adjusting the light intensity of each wavelength from 0 to 100% (in 1% step) is also possible.

Control from NIS-Elements software

With NIS-Elements imaging software, light intensity control of each wavelength is possible while keeping their intensity ratios. It also enables the emission of excitation light synchronized with image acquisition, and is effective for time-lapse imaging.

No vibration generation

The D-LEDI adopts a natural cooling system, which does not use cooling fans. This eliminates the generation of vibration and is suitable for high-magnification observation.

Maintenance free

The built-in LEDs have a long life of approximately 20,000-hours, and eliminate the need for frequent lamp replacement which was required with a mercury lamp light source.

Alignment free

With a mercury lamphouse, lamp centering adjustment was required. The LEDs in this light source are rigorously adjusted at the time of manufacture, and do not require a centering process.

Recommended filter cubes

Filter Cubes	Wavelength	Compatible LED
C-LED385	EX390/38, DM420, BA475/90	385 nm
C-LED470	EX470/40, DM500, BA534/55	470 nm
C-LED525	EX525/50, DM560, BA597/58	525 nm
C-LED625	EX621/58, DM660, BA706/73	625 nm

Objectives for Ni/Ci

Type	Use	Model	Immersion	NA	W.D. (mm)	Cover glass thickness	Correction ring	Spring loaded	Brightfield	Darkfield	DIC	Phase contrast	Polarizing	Fluorescence		
														UV	Visible light	NR
Super Fluor	Brightfield (CFI Super Fluor)	4X		0.20	15.50	—			○				△	○340	○	
		10X		0.50	1.10	0.17		✓	○	○●	○		△	○340	○	
		20X		0.75	1.00	0.17		✓	○	○●	○		△	○340	○	
		40XC		0.90	0.34-0.26	0.11-0.23	✓	✓	○	●	○		△	○340	○	
		40X Oil	Oil	1.30	0.19	0.17		✓w/stopper	○		○		△	○340	○	
		100XS Oil	Oil	0.50-1.30	0.20	0.17		✓	○	○●			△	○340	○	
Plan Fluor	Brightfield (CFI Plan Fluor)	4X		0.13	17.20	—			○				△	○	○	
		10X		0.30	16.00	0.17			○	△	○		○	○	○	
		20X		0.50	2.10	0.17			○	○●	○		○	○	○	
		20XC MI	Oil, water, glycerin	0.75	0.51-0.35 0.51-0.34 0.49-0.33	0-0.17	✓	✓	○	○●	○		○	○	○	
		40X		0.75	0.66	0.17		✓	○	○●	○		○	○	○	
		40X Oil	Oil	1.30	0.24	0.17		✓w/stopper	○		○		○	○	○	
		60XC		0.85	0.40-0.31	0.11-0.23	✓	✓	○	●	○		○	○	○	
		60XS Oil	Oil	0.50-1.25	0.22	0.17		✓	○	○●	○		○	○	○	
		100X Oil	Oil	1.30	0.16	0.17		✓w/stopper	○		○		○	○	○	
		100XS Oil	Oil	0.50-1.30	0.16	0.17		✓	○	○●	○		○	○	○	
	Phase contrast (CFI Plan Fluor)	DLL 10X		0.30	16.00	0.17			○	△			○ PH1	○	○	
		DLL 20X		0.50	2.10	0.17			○	○●			○ PH1	○	○	
		DLL 40X		0.75	0.66	0.17		✓	○	○●			○ PH2	○	○	
		DLL 100X Oil	Oil	1.30	0.16	0.17		✓w/stopper	○				○ PH3	○	○	
Apodized phase contrast (CFI Plan Fluor)	ADH 100X Oil	Oil	1.30	0.16	0.17		✓w/stopper	○				○ PH3	○	○		
Plan Apochromat	Brightfield (CFI Plan Apo)	Lambda D 2X		0.10	8.50	0/0.17			○					○CF	○	○
		Lambda D 4X		0.20	20.00	0/0.17			○					○	○	○
		Lambda D 10X		0.45	4.00	0.17			○	△	○		△	○	○	○
		Lambda D 20X		0.80	0.80	0.17		✓	○	●	○		△	○	○	○
		Lambda D 40XC		0.95	0.21	0.11-0.23	✓	✓	○	●	○		△	○CF	○	○
		Lambda D 60X Oil	Oil	1.42	0.15	0.17		✓	○		○		△	○	○	○
		Lambda D 100X Oil	Oil	1.45	0.13	0.17		✓	○		○		△	○	○	○
		VC 60XC WI	Water	1.20	0.31-0.28	0.15-0.18	✓	✓	○		○		○	○	○	
		NCG 100X Oil	Oil	1.40	0.16	0		✓	○		○		○	△	○	

Use: Water dipping *	Model	Immersion	NA	W.D. (mm)	Cover glass thickness	Correction ring	Spring loaded	Brightfield	Darkfield	DIC	Phase contrast	Polarizing	Fluorescence			Near-infrared DIC
													UV	Visible light		
DIC (CFI Plan Fluor)	10X W	Water	0.30	3.50	0			○	△	○		○	○	○	○	○
IR-DIC (CFI Apo)	NIR 40X W	Water	0.80	3.50	0			○	●	○		○	△	○	○	○
	NIR 60X W	Water	1.00	2.80	0			○	●	○		○		○	○	○
DIC (CFI Plan)	100XC W	Water	1.10	2.50	0	✓		○	●	○		○		○	○	○
DIC (CFI75)	LWD 16X W	Water	0.80	3.00	0			○	●	○		○	○	○	○	○

Note 1. Model name
The below letters, when included in the model names, indicate the respective features.
C: with correction ring
NCG: for use without cover glass
S: with iris
WI: water immersion type
W: water dipping type
MI: multi immersion (oil, water, glycerin) type

Note 2. Cover glass thickness
—: can be used without cover glass
0: use without cover glass

Note 3. Darkfield microscopy
Possible with the following
△: universal condenser (dry) and darkfield ring
○: above and darkfield condenser (dry)
●: darkfield condenser (oil)

Note 4. Phase rings are classified by objective NA
PHL, PH1, PH2, PH3: condenser cassette modules.

Note 5. Fluorescence microscopy (UV)
△: possible with visible light that has a longer wavelength than the excitation light used for DAPI
○: suitable
○: recommended for best results
340: high transmittance with an ultraviolet wavelength range of up to 340nm
CF: confocal imaging is possible at 488 nm and above

Note 6.
Brightfield/DIC/Fluorescence (visible light) microscopy
△: possible but not recommended
○: suitable
○: recommended for best results

Note 7. Polarizing
△: possible but not recommended
○: suitable
○: retardation measurement is possible with a polarizing microscope
* For Ni-E focusing nosepiece type

Ni Specifications

		Ni-E		Ni-U	Ni-L
		Focusing stage type	Focusing nosepiece type		
Main body	Optical system	CFI60 infinity optical system	CFI60 and CFI75 infinity optical systems	CFI60 infinity optical system	
	Focusing (stroke from focus point)	Via motorized stage Up/Down movement (Up 2 mm/Down 13 mm)	Via motorized nosepiece Up/Down movement (Up 13 mm/Down 2 mm)	Via manual stage Up/Down movement (Up 3 mm/Down 26 mm)	
		Built-in linear encoder, Resolution: 0.025 μm Motorized escape and refocus mechanism			
		Coaxial Coarse/Fine focusing			
	Illumination	Halogen light source (12V 100W), high color rendering LED light source*1: 50,000 hours of life*2 (optional) · NI-ND-E Motorized ND Filter (option)	Halogen light source (12V100W)	Built-in high color rendering LED light source*1: 50,000 hours of life*2	
Built-in fly-eye lens Built-in NCB11, ND8, ND32 filters (detachable, one additional filter mountable) and diffuser (non-detachable) ND2 filter (option)		Built-in fly-eye lens			
Controls	Transmitted light On/Off switch, Intensity control dial with preset function Image capture button				
	Built-in motorized control switches		—		
	· NI-ERG NI Ergo Controller (option)		· NI-SRCP Simple Remote Control Pad (option)		
Power supply unit	NI-CTLA External Power Supply Control Box A (for halogen illumination)/ NI-CTLA2 External Power Supply Control Box A2 (for LED illumination)		Built-in for halogen illumination	Built-in for LED illumination	
			NI-CTLB Control Box B is necessary when Motorized/Intelligent options are combined.		
Eyepieces (F.O.V. mm)		· CFI 10X (22) · CFI 12.5X (16) · CFI 15X (14.5) · CFI UW10X (25)			
Tubes	F.O.V. 22 mm (Eyepiece/Port)	· C-TB Binocular Tube · C-TE2 Ergonomic Binocular Tube (100/0, 50/50 via optional C-TEP2 DSC Port, C-TEP3 DSC Port C-0.55X or C-TEPF2.5 DSC Port F2.5X) Inclination angle: 10-30 degree, Extension up to 40 mm			
	F.O.V. 25 mm ³ (Eyepiece/Port)	· C-TF Trinocular Tube F (100/0, 0/100) · C-TT Trinocular Tube T (100/0, 20/80, 0/100) · NI-TT2 Quadrocular Tilting Tube (Eyepiece/Upper port/Rear port: 100/0/0, 0/100/0, 0/0/100) Inclination angle: 15-35 degree · NI-TT2-E Motorized Quadrocular Tilting Tube (Eyepiece/Upper port/Rear port: 100/0/0, 0/100/0, 0/0/100) Inclination angle: 15-35 degree			
Ports (F.O.V. 11 mm)	· C-TEP2 DSC Port for Ergonomic Binocular Tube (with C-mount adapter, 0.7X) · C-TEP3 DSC Port C-0.55X for Ergonomic Binocular Tube (with C-mount adapter, 0.55X) · C-TEPF2.5 DSC Port F2.5X for Ergonomic Binocular Tube (with F-mount adapter, 2.5X) · NI-BPU Back Port Unit (with C-mount adapter, 1.0X) · NI-RPZ DSC Zooming Port for Quadrocular Tube (with C-mount adapter, manual zoom, 0.6X - 2.0X)				
	· NI-RPZ-E Motorized DSC Zooming Port for Quadrocular Tube (with C-mount adapter, motorized zoom, 0.6X - 2.0X)				
Arms	· NI-SAM Standard Arm				
	· NIE-CAM Contact Arm (for Motorized/Intelligent options)		· NIU-CAM Contact Arm (for Motorized/Intelligent options)		
Nosepieces	Motorized	· NI-N7-E Motorized Septuple Nosepiece · NI-ND6-E Motorized DIC Sextuple Nosepiece	—	· NI-N7-E Motorized Septuple Nosepiece · NI-ND6-E Motorized DIC Sextuple Nosepiece	
	Intelligent	· NI-N7-I Intelligent Septuple Nosepiece	—	· NI-N7-I Intelligent Septuple Nosepiece	
	Manual	· D-ND6 DIC Sextuple Nosepiece · C-N6 ESD Sextuple Nosepiece ESD · C-N6A Sextuple Nosepiece with Analyzer Slot	· FN-S2N 2 Place Sliding Nosepiece (for CFI60 objectives) Changeover 2 objectives, DIC slider insertable · FN-MN-H CFI 75 Holder (for CFI75 objective) DIC slider insertable · FN-MN-H2 CFI 90 Holder (for CFI90 objective)	· D-ND6 DIC Sextuple Nosepiece · C-N6 ESD Sextuple Nosepiece ESD · C-N6A Sextuple Nosepiece with Analyzer Slot	

		Ni-E		Ni-U	Ni-L
		Focusing stage type	Focusing nosepiece type		
Stages		· NIE-CSRR2 Right Handle Rotatable Ceramic-coated Stage with 2S Holder Cross travel 78(X) x 54(Y) mm Handle height and torque adjustable	· FN-3PS2 FN1 Standard Stage Cross travel 30(X) x 30(Y) mm	· C-CSR15 Right Handle Ceramic-coated Stage with 1S Holder · C-CSR Right Handle Ceramic-coated Stage · NIU-CSRR2 Right Handle Rotatable Ceramic-coated Stage with 2S Holder Cross travel 78(X) x 54(Y) mm Handle height and torque adjustable	
		· NI-S-E Motorized XY Stage Resolution: 0.1 μm · NI-SH-D Dish Holder (option)			
Substages		· NI-SSR Substage (for Motorized Universal Condenser and Rotatable/Motorized stages)	· NI-SSF Substage for Focusing Nosepiece (for LWD condenser and FN1 Standard/Motorized stages)	· NI-SSR Substage (for Rotatable stage) · NI-SS Substage (for Non-rotatable stages)	
Condensers (NA)	Motorized	· NI-CUD-E Motorized Universal Condenser Dry (0.88) For DIC, phase contrast, darkfield observations Attached on NI-SSR Substage	—	—	
	Manual	· NI-CUD Universal Condenser Dry (0.88) · C-AB Abbe Condenser (0.90) · C-AR Achromat Condenser (0.80) · C-DO Darkfield Condenser Oil (1.20-1.43) · C-DD Darkfield Condenser Dry (0.80-0.95) · C-AA Achromat Aplanatic Condenser (1.40) · C-SA Slide Achromat Condenser 2-100X (0.90) · C-SW Swing-out Achromat Condenser 1-100X (0.90/0.11) · C-SWA Swing-out Achromat Condenser 2-100X (0.90/0.22) · C-LAR LWD Achromat Condenser (0.65) · D-CUO DIC Condenser Oil (1.40)	· FN-C LWD Condenser (0.78) (for DIC and oblique light illumination)	· NI-CUD Universal Condenser Dry (0.88) · C-AB Abbe Condenser (0.90) · C-AR Achromat Condenser (0.80) · C-DO Darkfield Condenser Oil (1.20-1.43) · C-DD Darkfield Condenser Dry (0.80-0.95) · C-AA Achromat Aplanatic Condenser (1.40) · C-DO Darkfield Condenser Dry (0.80-0.95) · C-SA Slide Achromat Condenser 2-100X (0.90) · C-SW Swing-out Achromat Condenser 1-100X (0.90/0.11) · C-PH Phase Contrast Turret Condenser (0.90) ⁴ · C-SWA Swing-out Achromat Condenser 2-100X (0.90/0.22) · C-LAR LWD Achromat Condenser (0.65) · D-CUO DIC Condenser Oil (1.40)	
Epi-fluorescence illuminator	Filter cube turret	6 filter cubes mountable, Noise Terminator mechanism for all turrets · NI-FLT6-E Motorized Epi-fluorescence Cube Turret Motorized shutter, Status check function ⁵ · NI-FLT6-I Intelligent Epi-fluorescence Cube Turret Manual shutter, Status check function ⁵ · NI-FLT6 Epi-fluorescence Cube Turret Manual shutter			
	Light distribution device	· NI-FLEI-2 Epi-fluorescence Attachment Aperture diaphragm and field diaphragm (Centerable/Detachable)			
	Option	—			
Epi-illumination light source		· D-LEDI Fluorescence LED Illumination system		· NL-SC Shutter Cassette for Ni-L	
Power consumption		211W (with max. halogen lamp intensity and full motorized options)	96W (with max. halogen lamp intensity and full motorized options)	Main body: 133W (with max. halogen lamp intensity) Control Box B: 29W (with full motorized options)	Main body: 28W (with max. high color rendering LED intensity) Control Box B: 68W (with full motorized options)
Weight (approx.)		29 kg (Epi-fluorescent configuration with motorized quadrocular tilting tube)	32 kg (Epi-fluorescent configuration with motorized quadrocular tilting tube)	20 kg (Brightfield configuration with ergonomic binocular tube)	18 kg (Brightfield configuration with ergonomic binocular tube)

*1 Cannot be used for IR-DIC observation.

*2 Estimate value based on Nikon's regulations.

*3 Eyepiece F.O.V.: When used with an expanded configuration such as a double layer of fluorescent cube turrets, eyepiece F.O.V. is 22 mm.

F.O.V. to imaging ports vary depending on the model.

*4 Can only be mounted on the NI-SS Substage.

*5 Status check function: Status of Filter/Nosepiece etc. can be recorded with captured images. Can be displayed on the PC operation screen.

Ni Dimensional diagram

Unit: mm

Ni-E (for use with focusing nosepiece)

Configured with a back port unit, two-tiered motorized epi-fluorescence cube turret and motorized quadrocular tilting tube

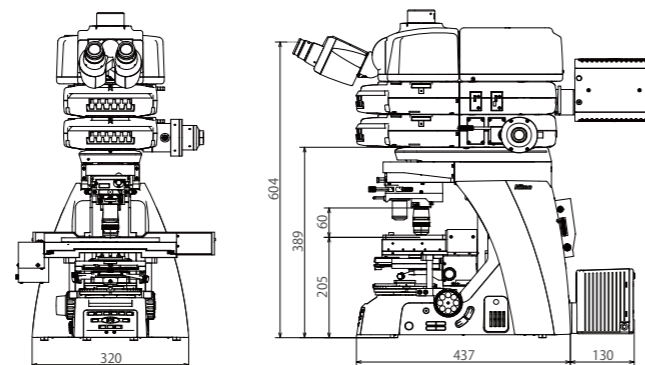

Ni-L

Configured with an epi-fluorescence cube turret and quadrocular tilting tube

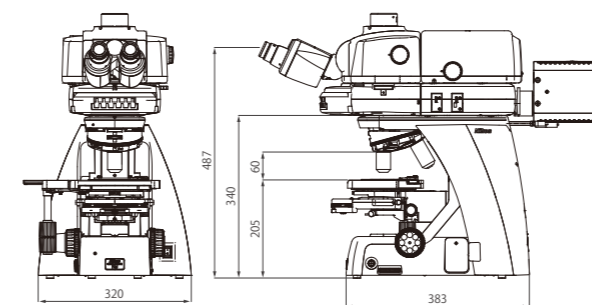

Ni-L

Configured with an ergonomic binocular tube and DSC port

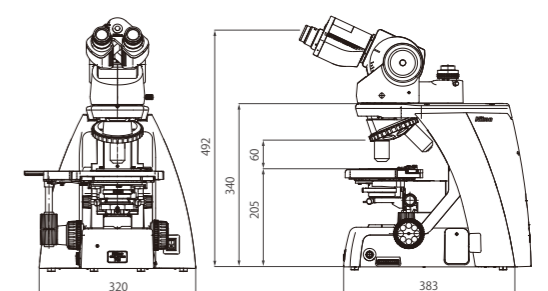

System diagram: Ni-E focusing stage type

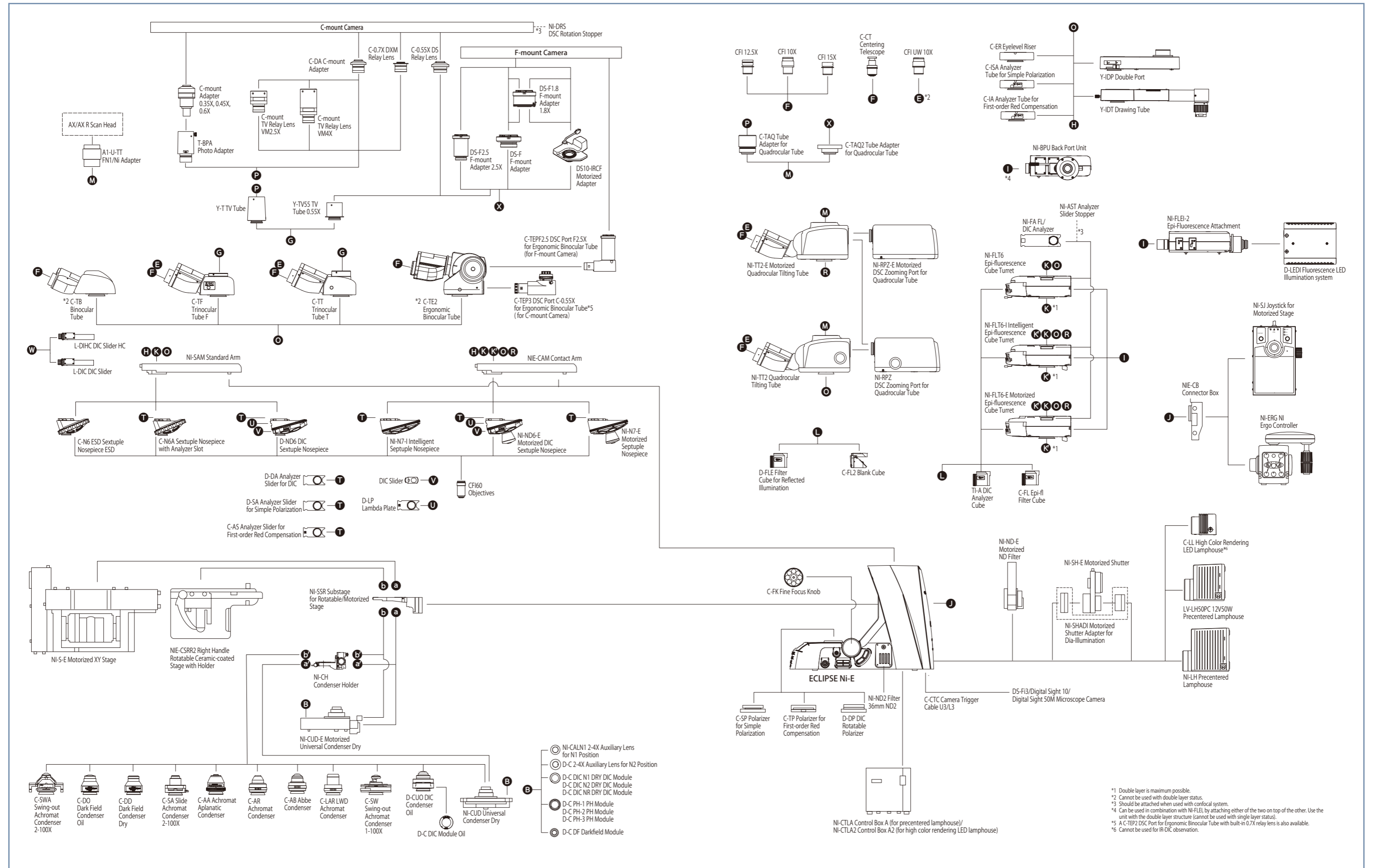

System diagram: Ni-E focusing nosepiece type

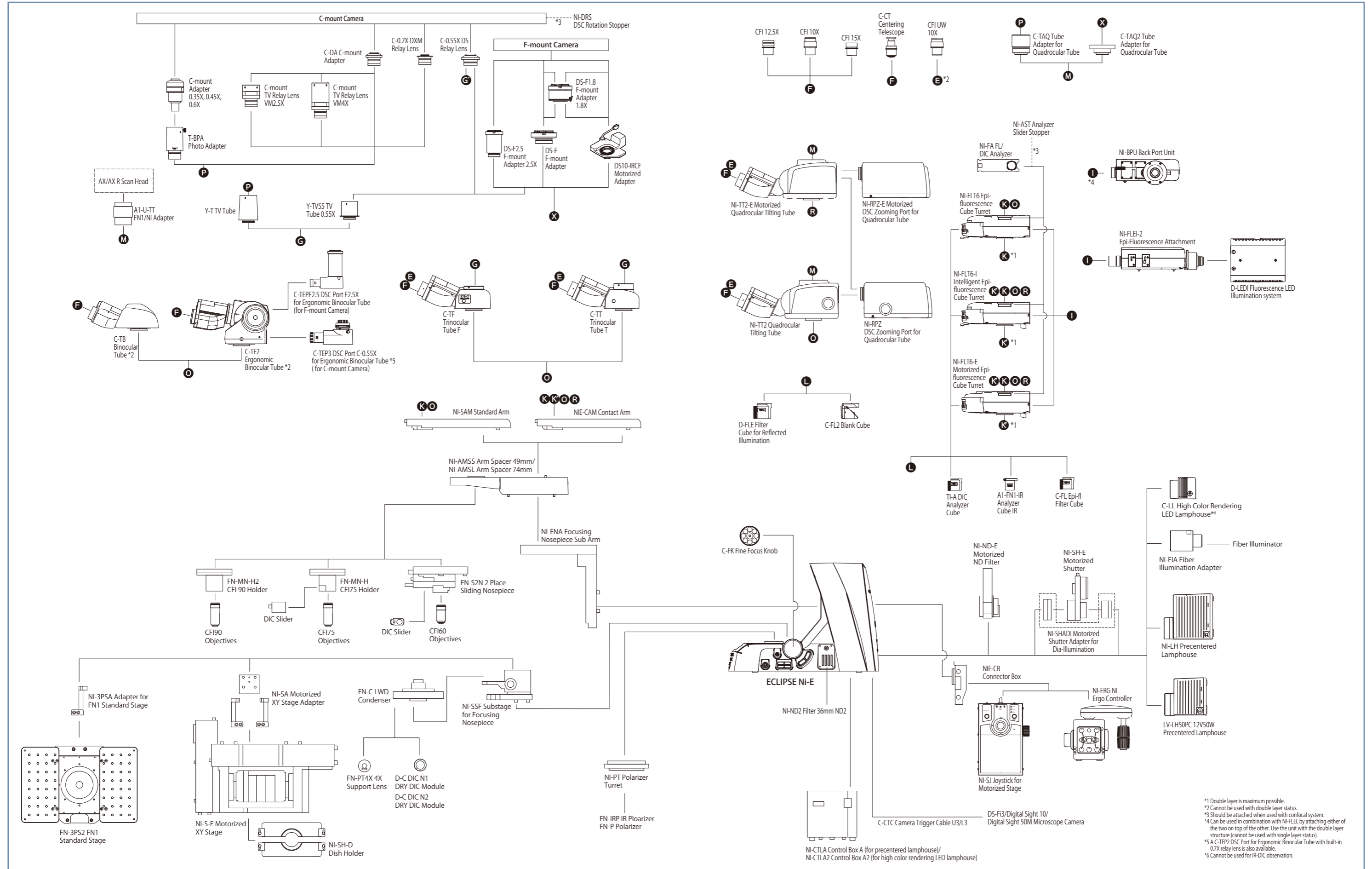

*1 Double layer is maximum possible.
 *2 Cannot be used with double layer status.
 *3 Should be attached when used with confocal system.
 *4 Can be used in combination with NI-FLEI, by attaching either of the two on top of the other. Use the unit with the double layer structure (cannot be used with single layer status).
 *5 A C-TEP2 DSC Port for Ergonomic Binocular Tube with built-in 0.7X relay lens is also available.
 *6 Cannot be used for IR-DIC observation.

System diagram: Ni-U/Ni-L

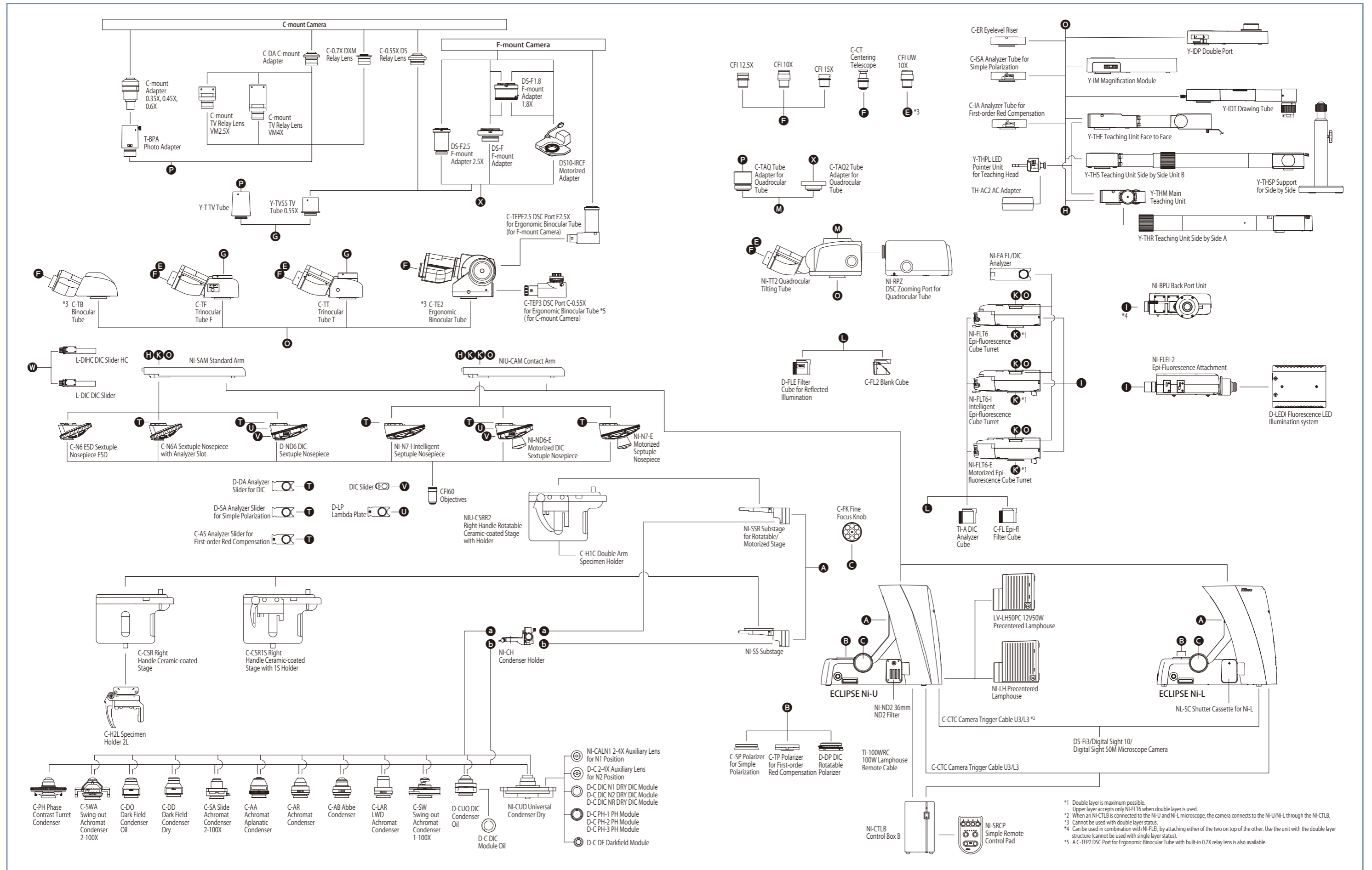

Ci Specifications

		Ci-E	Ci-L plus
Main body	Optical system	CFI60 Infinity Optical System	
	Illumination	High luminescent White LED Illuminator (Eco-illumination)	
		Automatic intensity reproduction function	Light Intensity Management (LIM) feature for auto intensity reproduction, with ECO mode* ¹ and Sleep mode* ²
	Controls	Image capture button	
		Nosepiece rotating buttons Remote control pad	—
Eyepieces (F.O.V. mm)	Sleeve diameter ϕ 30mm · CFI 10X (22) · CFI 12.5X (16) · CFI 15X (14.5) · CFI UW 10X (25)		
Focusing	Coaxial Coarse/Fine focusing, Focusing stroke: 30 mm, Coarse: 9.33 mm/rotation, Fine: 0.1 mm/rotation, Minimum reading: 1 μ m Coarse motion torque adjustable, Refocusing function		
Tubes	F.O.V. 22 mm	· C-TB Binocular Tube · C-TE2 Ergonomic Binocular Tube (Eyepiece:Port=100:0, 50:50 via optional C-TEP2 DSC Port, C-TEP3 DSC Port C-0.55X or C-TEPF2.5 DSC Port F2.5X) Inclination angle: 10-30 degree, Extension: up to 40 mm	
	F.O.V. 25 mm	· C-TF Trinocular Tube F (Eyepiece:Port=100:0, 0:100) · C-TT Trinocular Tube T (Eyepiece:Port=100:0, 20:80, 0:100)	
Nosepieces	· Motorized Sextuple Nosepiece with Analyzer Slot (Included with Ci-E) Switching between two objectives function* ³	· Exclusive Intelligent Sextuple Nosepiece with Analyzer Slot (Included with Ci-L plus)	
Stages	Cross travel 78 (X) \times 54 (Y) mm, with vernier calibrations, stage handle height and torque adjustable for all stages · C-SR2S Right Handle Stage with 2S Holder · C-CSR1S Right Handle Ceramic-coated Stage with 1S Holder · C-CSR Right Handle Ceramic-coated Stage (C-H1L Specimen Holder 1L and C-H2L Specimen Holder 2L are optional)		
Condensers (NA)	Motorized	· CI-C-E Motorized Swing-out Condenser (0.90/0.22) Focusing stroke: 27 mm	
	Manual	Focusing stroke: 27 mm · C-AB Abbe Condenser (0.90) · C-AR Achromat Condenser (0.80) · C-DO Darkfield Condenser Oil (1.20-1.43) · C-DD Darkfield Condenser Dry (0.80-0.95) · C-PH Phase Contrast Turret Condenser (0.90) · C-AA Achromat/ Aplanat Condenser (1.40) · C-SA Slide Achromat Condenser 2-100X (0.90) · C-SW Swing-out Achromat Condenser 1-100X (0.90/0.11) · C-SWA Swing-out Achromat Condenser 2-100X (0.90/0.22) · C-LAR LWD Achromat Condenser (0.65)	
Observation methods* ⁴	Brightfield, Epi-fluorescence, Darkfield, Phase contrast, Simple polarizing, Sensitive color polarizing		
Epi-fluorescence attachment	· CI-FL-2 Epi-fluorescence Attachment (4 filter cubes mountable)		
Epi-fluorescence light source	· D-LED1 Fluorescence LED Illumination system (32W) · C-HGF1/HGFIE HG Precentered Fiber Illuminator Intensilight (130W)		
Power consumption	13W (Brightfield configuration)		5W (Brightfield configuration)
Weight (approx.)	15.4 kg (Binocular standard set)		13.3 kg (Binocular standard set)

*1 Energy saving feature that turns off the illumination and LCD to put it into a low power consumption state (sleep mode) after a certain period of inactivity.

*2 Standby state with low power consumption, though it is always energized while the dedicated AC adapter is connected.

*3 Settings with the remote control pad are required.

*4 Optional accessories are required for observations other than brightfield.

Ci Dimensional Diagram

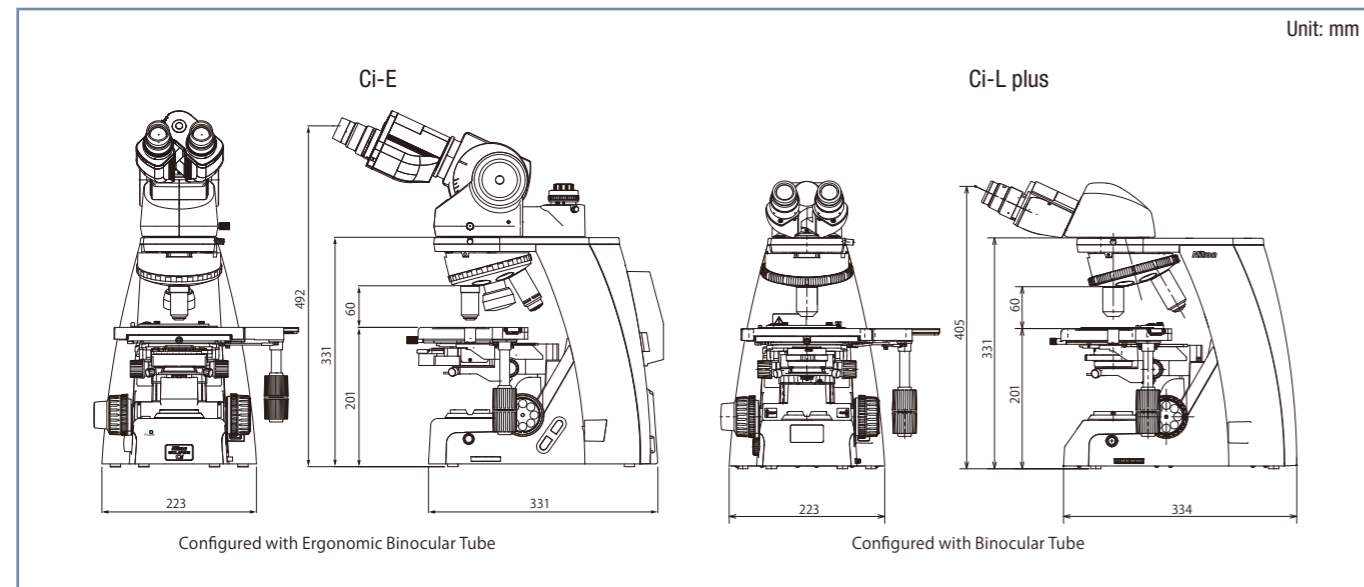

Ci System Diagram

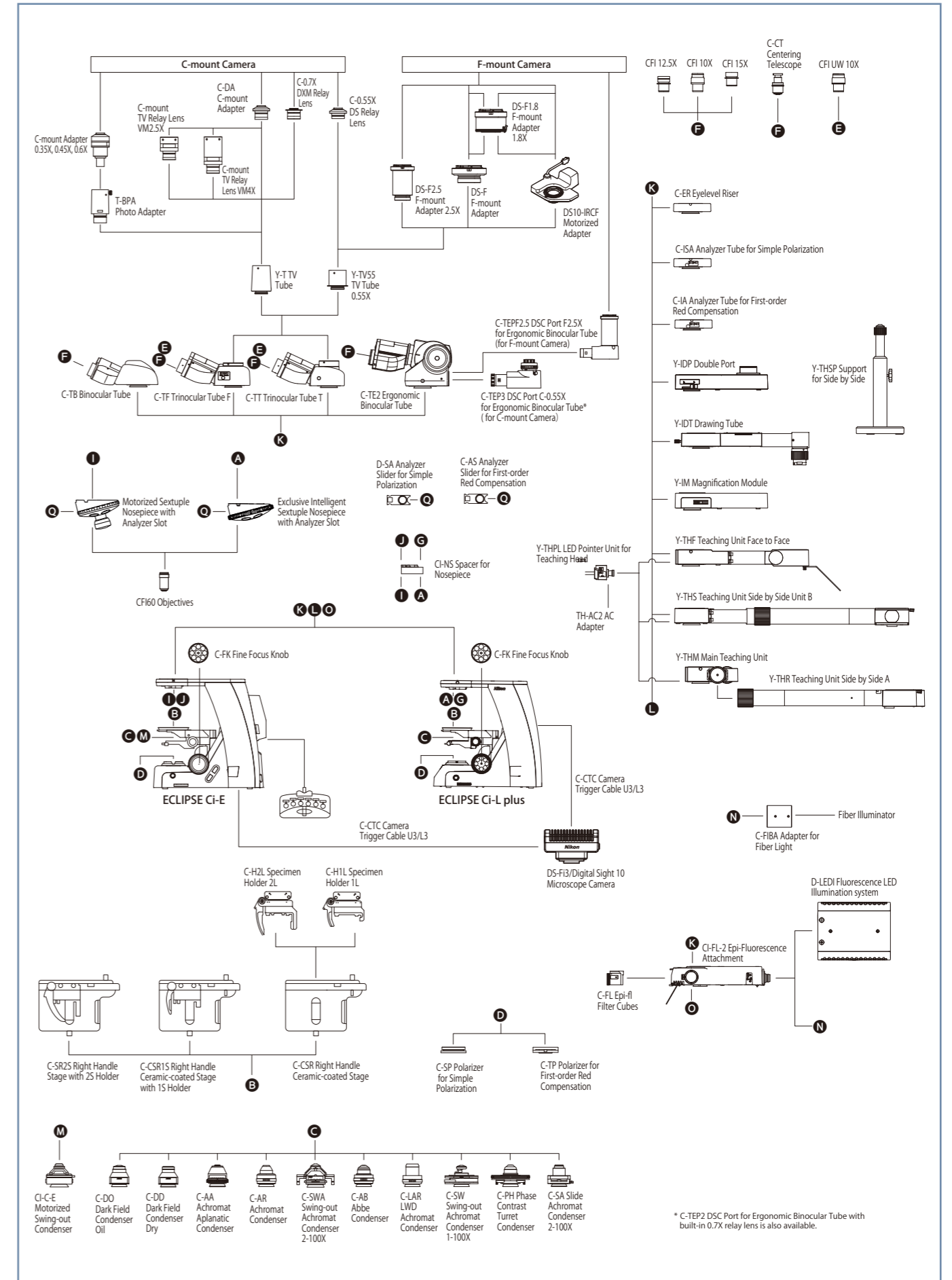

The Digital Sight series and Imaging Software NIS-Elements are not for clinical diagnostic use.

Company names and product names appearing in this brochure are their registered trademarks or trademarks.
N.B. Export of the products* in this brochure is controlled under the Japanese Foreign Exchange and Foreign Trade Law.
Appropriate export procedure shall be required in case of export from Japan.
*Products: Hardware and its technical information (including software)
Monitor images are simulated.



Specifications and equipment are subject to change without any notice or obligation on the part of the manufacturer. June 2023 ©2011-23 NIKON CORPORATION



NIKON CORPORATION

Shinagawa Intercity Tower C, 2-15-3, Konan, Minato-ku, Tokyo 108-6290, Japan
phone: +81-3-6433-3705 fax: +81-3-6433-3785
<https://www.healthcare.nikon.com/en/>

Nikon Instruments Inc.

1300 Walt Whitman Road, Melville, N.Y. 11747-3064, U.S.A.
phone: +1-631-547-8500; +1-800-52-NIKON (within the U.S.A. only)
fax: +1-631-547-0299
<https://www.microscope.healthcare.nikon.com/>

Nikon Europe B.V.

Stroombaan 14, 1181 VX Amstelveen, The Netherlands
phone: +31-20-7099-000
https://www.microscope.healthcare.nikon.com/en_EU/

Nikon Precision (Shanghai) Co., Ltd.

CHINA phone: +86-21-6841-2050 fax: +86-21-6841-2060
(Beijing branch) phone: +86-10-5831-2028 fax: +86-10-5831-2026
(Guangzhou branch) phone: +86-20-3882-0550 fax: +86-20-3882-0580
<https://www.nikon-precision.com.cn/>

Nikon Canada Inc.

CANADA phone: +1-905-625-9910 fax: +1-905-602-9953

Nikon France, Succursale de Nikon Europe B.V.

FRANCE phone: +33-1-4516-4516

Nikon Deutschland, Zweigniederlassung der

Nikon Europe B.V.

GERMANY phone: +49-211-9414-888

Nikon Italy, Branch of Nikon Europe B.V.

ITALY phone: +39-055-300-9601

Nikon Europe B.V., Amstelveen, Zweigniederlassung

Schweiz (Egg/ZH)

SWITZERLAND phone: +41-43-277-2867

Nikon UK, Branch of Nikon Europe B.V.

UNITED KINGDOM phone: +44-208-247-1717

Nikon Österreich, Zweigniederlassung der Nikon Europe B.V.

AUSTRIA phone: +43-1-972-6111

Nikon Singapore Pte. Ltd.

SINGAPORE phone: +65-6559-3651 fax: +65-6559-3668

Nikon Australia Pty Ltd

AUSTRALIA phone: +61-2-8767-6900

Nikon Instruments Korea Co., Ltd.

KOREA phone: +82-2-6288-1900 fax: +82-2-555-4415

Nikon India Private Limited

INDIA phone: +91-124-4688-500

